

# MOB-61 Printer User Manual

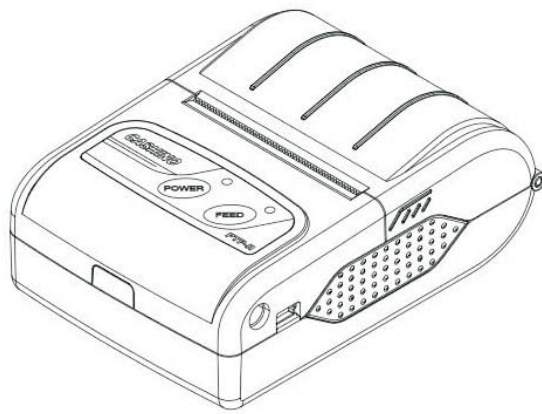

---

## Maxim Peripherals Pvt. Ltd.

---

106/101, Pradhan Bldg., Aarey Road (Near Subway), Goregaon (East), Mumbai 400 063, India.  
Ph. : +91-22-29275039 Email : [support@maximtpl.com](mailto:support@maximtpl.com) Website : [www.maximtpl.com](http://www.maximtpl.com)

## Revision Record

No.	Date	Description	Edited Page	Draft / Modification	Review
1	20170417	The first draft		Lin Xiaopeng	Huang Zongze

# Contents

Cautions.....	4
1.Introduction.....	7
1.1 Features.....	7
2. Accessory.....	7
2.1 Standard accessories.....	7
2.2 Options accessories.....	8
3.Printer exterior.....	8
3.1 Front.....	8
3.2 Back.....	8
4.Function characters.....	9
5.Prepare before using.....	10
5.1 Battery installation considerations.....	10
5.2 Li-ion battery installation.....	10
5.3 Paper loading.....	11
6. Basic function using.....	11
6.1 Turn on.....	11
6.2 Turn off.....	11
6.3 Inspect itself.....	12
6.4 Paper feeding.....	12
6.5 Charging.....	12
6.6 LED Indicator and buzzer definition.....	12
6.7 Auto dormancy/automatic awaken, automatic turnoff.....	12
6.8 Preprinted black mark specification.....	13
7.Communication.....	13
7.1 serial communication (RS232).....	14
7.2 USB communication.....	15
7.3 Bluetooth Communication.....	15
7.4 WIFI Communication.....	16
7.5 RAW-IR Communication.....	17
8. Maintenance and maintenance.....	17
8.1 Daily maintenance.....	17
8.2 usage and preservation of print paper.....	17
9.Fault diagnosis.....	17

# MOB-61 Printer



## Cautions

♦ Safety precautions before using the equipment, please remember the following safety regulations to prevent any damage or property loss.

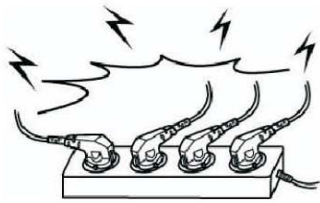

### WARNING

Violating following instructions can cause serious injury or death.

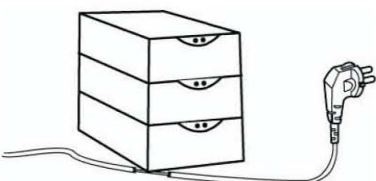
<p><b>Do not plug several products in one multi-outlet.</b></p> <ul style="list-style-type: none"><li>• This can provoke over-heating and a fire.</li><li>• If the plug is wet or dirty, dry or wipe it before usage.</li><li>• If the plug does not fit perfectly with the outlet, do not plug in.</li><li>• Be sure to use only standardized multi-outlets.</li></ul>  <p>PROHIBIT</p>	<p><b>You must use only the supplied adapter.</b></p> <ul style="list-style-type: none"><li>• It is dangerous to use other adapters.</li></ul>  <p>PROHIBIT</p>
<p><b>Do not pull the cable to unplug.</b></p> <ul style="list-style-type: none"><li>• This can damage the cable, which is the origin of a fire or a breakdown of the printer.</li></ul>  <p>PROHIBIT</p>	<p><b>Keep the plastic bag out of children's reach.</b></p> <ul style="list-style-type: none"><li>• If not, a child may put the bag on his head.</li></ul>  <p>PROHIBIT</p>
<p><b>Do not plug in or unplug with your hands wet.</b></p> <ul style="list-style-type: none"><li>• You can be electrocuted.</li></ul>  <p>PROHIBIT</p>	<p><b>Do not bend the cable by force or leave it under any heavy object.</b></p> <ul style="list-style-type: none"><li>• A damaged cable can cause a fire.</li></ul>  <p>PROHIBIT</p>

# MOB-61 Printer



## CAUTION

Violating following instructions can cause slight wound or damage the appliance.

If you observe a strange smoke, odor or noise from the printer, unplug it before taking following measures.

- Switch off the printer and unplug the set from the mains.
- After the disappearance of the smoke, call your dealer to repair it.

TO UNPLUG



Keep the desiccant out of children's reach.

- If not, they may eat it.

PROHIBIT



Install the printer on the stable surface.

- If the printer falls down, it can be broken and you can hurt yourself.

PROHIBIT

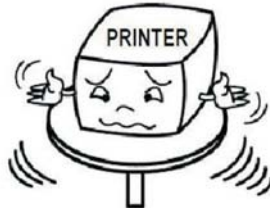

Use only approved accessories and do not try to disassemble, repair or remodel it for yourself.

- Call your dealer when you need these services.
- Do not touch the blade of auto cutter.

DISASSEMBLING  
PROHIBITED



Do not let water or other foreign objects in the printer.

- If this happened, switch off and unplug the printer before calling your dealer.

PROHIBIT



Do not use the printer when it is out of order. This can cause a fire or an electrocution.

- Switch off and unplug the printer before calling your dealer.

TO UNPLUG



### ♦ Operation Precautions

Be sure not to print continuously over 1meter, otherwise may cause damage to the printer head. Water or other liquid should not spill into the printer, also the printer should not be appeared in the rain, or else may cause printer damage.



## MOB-61 Printer

Please do not open the paper case cover when printing; otherwise the printer may work improperly. If print with serial interface, should not unplug the interface cable in the course of printing, or else some printing data may be lost.

When print in Ir or IrDA mode, be sure the Ir window of the host equipment face rightly the Ir window of the printer, the distance should be within the range of 50cm, and the angle should be within the range of 30°.

When print with Bluetooth interface, the communication distance should be within 10 meters, otherwise the printer doesn't print or prints rubbish codes.

Too high(50°C) or too low(-10°C)temperature and too high(80%) or too low (20%) relative humidity both effect the quality.

The print paper in poor quality or stored for too long time also may reduce the print quality even damage the printer.

In the black mark detecting mode, the printer requires that the preprinted black mark is accordant with the black mark specifications (details please refer to 4.2); otherwise the black mark can not be detected correctly.

Be sure to use up the power of the battery before charge it, as it can ensure the using life of the battery.

### ◆ Storage Precautions

The printer should be placed in such an environment that the temperature is between -20°C and 70°C, and the relative humidity is between 5% and 95%.

If the printer will be stored for a long time, please be sure to take out the battery, otherwise may damage the battery and printer.

Normal thermal paper can't be kept too long time. If you need to keep the receipt for a long period, please choose long term effective thermal paper.

The paper should be keep away from high temperature environment and point-blank sunshine.

### ◆ Battery Safety Precautions.

Be sure to carefully read the user manual before using the produce.

Ignore the following instructions may cause battery overheating, fire, explosion, damage and/or performance, and reduced product life.

- 1) Risk of explosion if battery is replaced by an incorrect type.
- 2) Dispose of used batteries according to the instructions.
- 3) Do not allow water, sea water from entering or leaking into the battery inside. If the batteries internal safety device burn, when changing it, it may produce any abnormal current and/or voltage, and cause any abnormal chemical reaction, then may cause the battery overheating, fire and/or explosion.
- 4) Do not use or place the battery nearby the stove or other high temperature places. Excessive heats maybe damage the resin shell and/or the insulation materials, and then the battery may be caused overheating, burning and/or explosion.
- 5) When charging, use a specified charger. Other conditions (high temperature, high pressure/high current, using the modified battery charger, etc) excludes here may result in over-charging the battery and abnormal current and/or voltage, cause abnormal chemical reaction, and may cause the battery overheat, light and/or explosion.
- 6) Battery clearly marks with positive and negative. When connect the battery with the charger and/or printer, be sure to verify the correct battery orientation. Reverse insertion will cause the reverse charging and may cause abnormal chemical reaction, and then may cause the battery overheat, ignite, and/or explosion.
- 7) Do not make the battery contact with the power outlet and/or car cigarette lighter socket. This may cause high pressure and excessive current, and lead to the battery overheat, burning and/or explosion.

## MOB-61 Printer

8) Do not heat the battery or put the battery into fire. This may melt insulation material and/or damage safety devices or safety equipment, then ignite electrolytic solution, and cause the battery overheat, burning and/or explosion.

9) Do not use the battery with contrary (+) and (-) Location. In the charging process, this will cause the reverse charging and may cause abnormal chemical reaction. During use, may appear unpredictable current exception, and cause the battery overheat, ignite, and/or explosion.

10) Do not make the battery (+) and (-) contact with any metal. Also, do not carry along or store batteries with metal objects, such as necklaces, hair clips and so on. Battery internal short circuit may cause excessive current, and lead to the battery overheats, ignite, and/or explosion and the adjacent metal objects (necklaces, hairpins, etc.) may be overheating.

11) Do not throw or heavy attack the battery. If internal safety device of the batteries burn, the battery charging may cause any abnormal current and/or voltage, and abnormal chemical reaction, and lead to the battery overheat, ignite, and/or explosion.

## 1.Introduction

This product is a high efficient portable printers, it's small, weights light, high durability, printing long duration, widely used in mobile POS, retail, parking tickets, logistics, shipping, warehouse, utility bill, etc.

### 1.1 Features

- ※ Equipped with lithium battery, can work continuously for 8 hours
- ※ Portable devices suitable for outdoor use.
- ※ Anti-throw capacity can reach 1.2 m (cement floor)
- ※ Support all 1D barcode and 2D( QR code ) printing
- ※ 7.4V/2000mAh large capacity battery with low power design and automatic sleep wake up function, work time longer. (Also have 1600mAh for choose)
- ※ RS232C, USB, Bluetooth, WIFI, Raw-IR, wired and wireless for choose
- ※ Emulation ESC/POS commands
- ※ Supply Windows driver
- ※ Supply Android and IOS demo and SDK

## 2. Accessory

### 2.1 Standard accessories



MOB-61



Battery

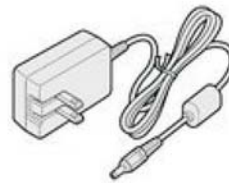

AC Adapter

## MOB-61 Printer

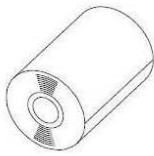

Paper Roll



User Manual



USB Cable

## 2.2 Options accessories

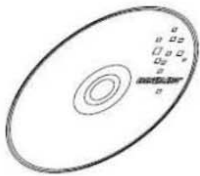

CD



car charger

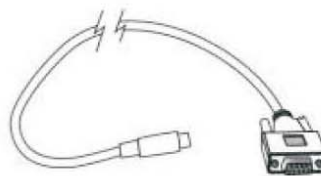

Serial Interface Cable

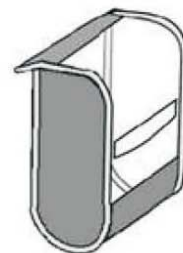

Protective Case

## 3.Printer exterior

### 3.1 Front

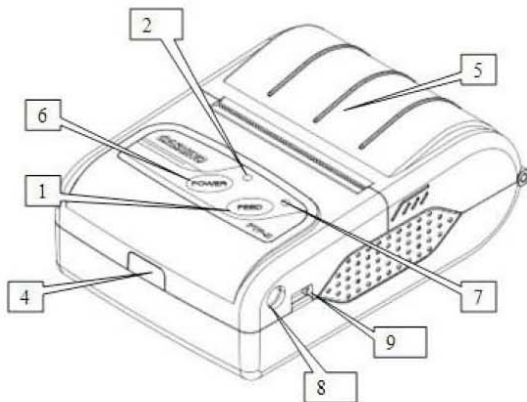

### 3.2 Back



## MOB-61 Printer

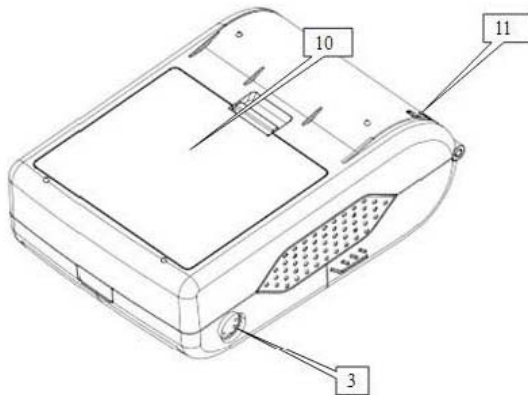

1. Feed paper key
2. State indicator light
3. RS232 serial port socket
4. Infrared ray(IR) interface
5. Printer upper cover
6. Power key
7. Power Charging indicator light
8. Power port
9. Mini USB port
10. Battery
11. Leather hang

Note: The status indicator and charging indicator light separately be set in above of the two keys. Using red and blue to show different mean.

## 4.Function characters

Model	MOB-61		
Printing method	Line thermal printer		
Printing speed	50~80mm/s		
Dot pitch	8dots/mm, 384 dots/line		
Printing width	48mm		
Paper width	57.5±0.5mm		
Paper roll outer diameter	40mm (Max.)		
Paper roll inner diameter	13mm(Min.)		
Paper thickness	60-80um		
Overall dimension(W)	79x112x45mm		

## MOB-61 Printer

xDxH):				
Weight ( g )	280 (Including battery, paper roll )			
Printing characters	ANK: 8x16,9x17, 9x24,12x24 GBK:24x24			
Characters/line	ANK:48, 42, 32 GBK:24, 16			
Life cycle time	50km(printing density under 12.5%)/100 million pulses			
Barcode type	1D: UPC-A,UPC-E,EAN-13,EAN-8,CODE39,CODE93, CODE128,CODEBAR,ITF25			
	2D: QR CODE, PDF417			
interface	RS232,USB	RAW-IR , RS232,USB	Bluetooth V2.0 / V4.0 RS232,USB	WIFI, RS232, USB
Power	2000mAh 7.4V rechargeable Lithium battery			
Recharge adapter	12V,0.8A Stand by recharging / AC adapter			
Black mark test	Supported			
Paper feeding	Easy paper loading			
Paper cut	By hands			
commands	ESC/POS compatible with order sets			
operate setting	Temperature -10°C~-50°C ; Humidity 20%~85%			
Recharge Setting	Temperature 5°C~40°C; Humidity 20%~85%			
Storage Setting	Temperature -20°C~70°C ; Humidity 5%~95%			
Standard accessories	Li-ion battery, AC adapter, USB cable, paper roll , user manual			
Optional accessories	Serial interface cable/CD/Car charger/leather coat			

## 5.Prepare before using

### 5.1 Battery installation considerations

Manufactured products, battery not packed into the printer; Please put the battery into the battery.

Note: when using the battery for the first time, please charge full of electricity. After long-term storage battery to be charged first, the battery will reach the best effect of use.

### 5.2 Li-ion battery installation

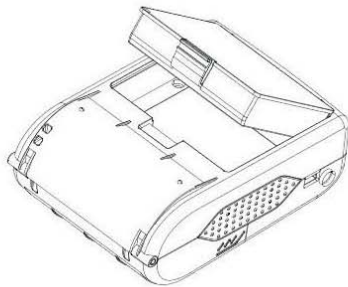

## MOB-61 Printer

- 1) Refer to the picture, put the battery in the battery slot, and please pay attention to the correct positive and negative.
- 2) Close the battery case.

### 5.3 Paper loading

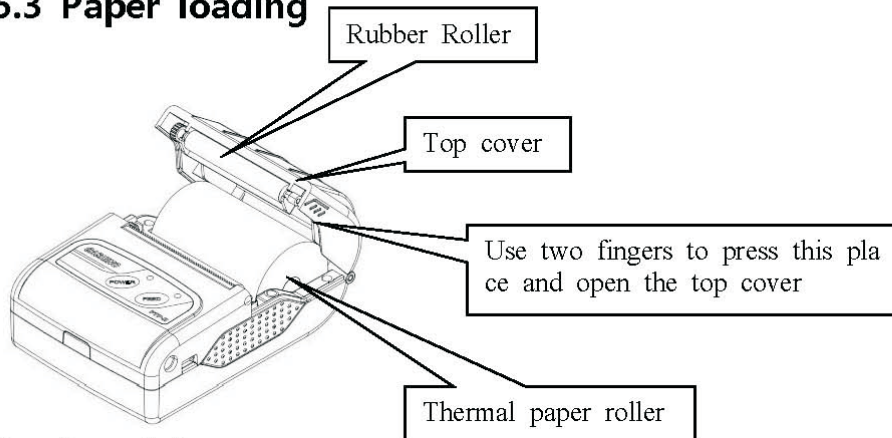

#### Operation methods:

- 1) Use two fingers to press the place showed in the above picture and open the top cover.
- 2) Put the paper roll into the paper case, pay attention to the direction of paper. If loaded reversely, it won't print.
- 3) Pull paper out of paper case.
- 4) Make sure paper in the center then closed top cover.

## 6. Basic function using

### 6.1 Turn on

Under the close state, Press  [POWER] button 2 seconds, the printer enters to the working state, the power indicator light (Red).

NOTE: in cash the printer function indicator light(Blue) flash and with paper, it show the power will to be exhaust, if continue to use, please change one new battery or charging power.



### 6.2 Turn off

Opening state, press  [POWER] button in 2 seconds, the printer will be closed, all the indicator light will be off.

## MOB-61 Printer

### 6.3 Inspect itself

The user can inspect the printer by themselves after getting the printer. To check the current state and setting.

Inspect method: turn-off. Hold  [FEED] button, and then press  [POWER] button the printer will print out the inspect page, the inspect page including the current state, setting, example of printer.

### 6.4 Paper feeding

Under the usual working state, press  [FEED] button, start to feed paper, and will stop till 250mm.

### 6.5 Charging

When the power of batter to be exhausted, the function indicator shows (Blue) and flash, at the same time, the printer will give an alarm, at the comment, the user should charge the power.

The charging method: connect to the power 100-240VAC,50/60HZ,during the charging , the charging indicator light show blue and flash till finished, at the same time , the charging indicator light have been lighting

During charging, the user can usually use the printer.

### 6.6 LED Indicator and buzzer definition

MOB-61 has one buzzer and two LED indicators to indicate the printer status. The LED indicators indicate current status and buzzer indicates the changes of status.

LED indicator ( Blue )	LED indicator ( red )	Printer status	Buzzer
Flash quickly	Lamp off	Charging	
Flash slowly	Lamp off	power lack	Alarm one time in Every minutes
Bright continuously	Lamp off	Finish charging	Double beep in one time
Lamp off	Bright continuously	Working	
Flash slowly	Flash slowly	Paper end	Continuous chirping
Lamp off	Flash slowly	dormancy	

### 6.7 Auto dormancy/automatic awaken, automatic turnoff

In order to save energy, prolong the using time, MOB-61 printer adopts the advanced automatic dormancy, automatic awaken technology.



## MOB-61 Printer

After turning on the Printer, if without any data sent to the printer by the host within one minute, and without pressing any buttons, the printer will be entering to the dormancy mode and the state indicator light (RED) will be in a state of slow flash .

After dormancy, the power consumption greatly reduced, and it will not affect the using. When receiving any printing data, the printer will be awoken automatically, without any other manual intervention.

After 2 hours, the printer does not receive any data, the printer will automatically turn off, and you should start it by manual.

### 6.8 Preprinted black mark specification

If user wants to locate receipt by detecting preprinted black mark, shall accord to the following specification for the black mark. Otherwise it may cause printer can't recognize the black mark.

Printing position: black mark shall preprint at the left side of receipt.

Width rang :  $\geq 7\text{mm}$

Height :  $4\text{mm} \leq \text{height} \leq 6\text{mm}$

Reflection rate to IR :  $< 10\%$  ( reflection rate to the black mark on paper  $> 65\%$  )

Hps : Hps indicates the distance from down edge of detecting mark from beginning line.

$0\text{mm} \leq \text{Hps} \leq 1\text{mm}$

Black mark preliminary printing standard

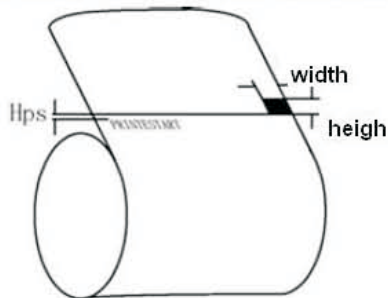

## 7.Communication

PTP - II printer has two kinds of communication methods

## MOB-61 Printer

- (1) Wired : USB/RS232C
- (2) wireless bluetooth/wi-fi/ir

### 7.1 serial communication (RS232)

The printer have one DB-9 serial port cable as option

(one port connect to the printer, the other connect to MINI DIN plug)

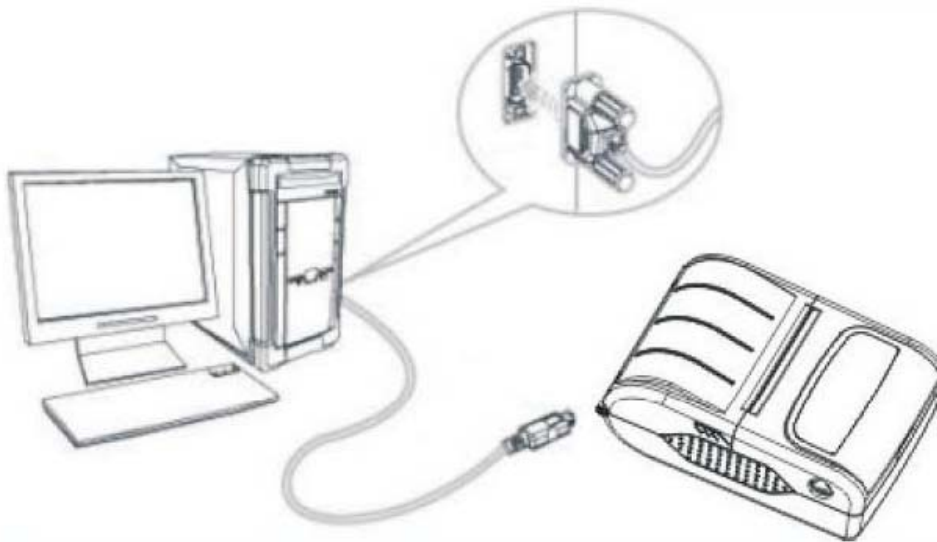

Socket pin defined as shown in the figure below:

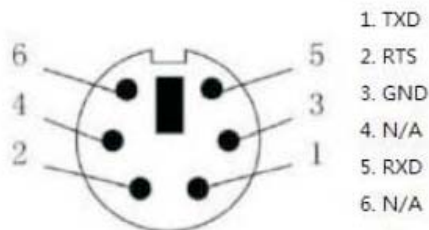

No.	Definition	Declare
1	TXD	Transmit data (printer out put)
2	RTS	Printer request data
3	GND	Ground

## MOB-61 Printer

### 7.2 USB communication

MOB-61 printer has a mini USB interface , to achieve it through the mini USB USB2.0 interface.

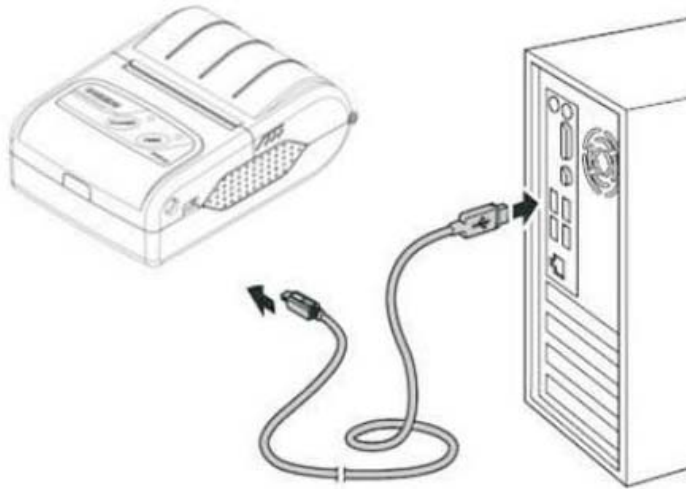

**Note :** Printer using USB communication, need to install PL2303 driver first. Printer contact computer USB,than open" my printer" --" device manager" --" combo" ,will see this icon,illustrate that successfully install driver,and use normally.

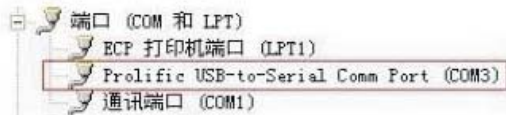

eg : For instance: If you pull up USB cable, the icon disappear, and it appear reconnection. That shows COM3 is the port connect printer with computer.

### 7.3 Bluetooth Communication

## MOB-61 Printer

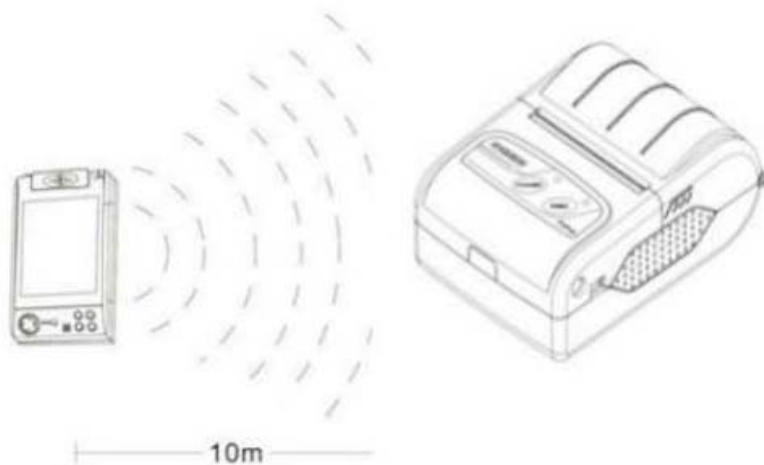

Matching method is as follows:

- 1 . Power on,
- 2 . The main equipment for external bluetooth devices,
- 3 . If you have more external bluetooth devices, selected inhibits MOB-61 printer,
- 4 . Enter the default password is "0000" or obtained bluetooth password by printer self-test page
- 5 . Complete the matching.

## 7.4 WIFI Communication

Printer can be connected to other sites, such as PDA and PC, support wireless LAN application mode of communication.

Printer can check bluetooth environment(authentication,encryption,connection mode) and wireless local area network(LAN) environment (IP,SSID,authentication,encryption)by self-test page.

The printer IP address, can't with other terminal IP address conflict.

Combo : Setting by yourself.

Subnet Mask : In accordance with the router.

Gateway : In accordance with the router.

Note: IP and gateway must with routers are on the same network



## MOB-61 Printer

### 7.5 RAW-IR Communication

MOB-61 portable thermal printer can use IR to communicate with the host for transmitting the data.

Printer can't work at the same time in a state, the original infrared VJR or IrCOMM condition, if the printer is not working in the condition of what you need, must be to use the printer to reset.

When MOB-61 communicates with the host devices make the IR interfaces ( from both MOB-61 and the host device ) right towards to each other ( angle shall not be more than 30° ), without any obstacles between them, the distance shall be less than 0.5M.

## 8. Maintenance and maintenance

### 8.1 Daily maintenance

- 1.Please use cloth to clean inside and outside of the printer.
- 2.Please clean printer mechanism regularly.Especially the clean method when print quality turns bad.Please use absorbent cotton with absolute alcohol to clean printer mechanism.
- 3.Please take the battery out when the printer is bilging,and airing printer.
- 4.Please take the battery out and keep it separated with printer if won' t use it for a long time.

### 8.2 usage and preservation of print paper

- 1.Please avoid to preserve printer paper in high temperature and direct sunlight places.And please do not tear off the package when preserve.
- 2.Please preserve printed paper about 20 degrees Celsius places after printing,to lengthen life-span of printed paper.
- 3.Please choose good quality thermal paper if you want to keep it for long time.

## 9.Fault diagnosis

## MOB-61 Printer

Fault phenomenon	Fault cause	Solutions
It beeps two times continuously .	Paper out	Please install paper roll correctly.
It beeps two times discontinuously,	Low battery	Please charge
It doesn' t print when feeding.	Install paper roll in opposite direction.	Please re-install.
It prints hazily.	Printer mechanism is dirty.	Please clean printer mechanism.
	Words in bad quality of printer paper.	Please set print density and print quality or use better quality paper.
It beeps three times continuously.	Printer cover is open when printing.	Close printer cover,
Words are blurry in a short time.	Print paper quality is not good.	Please use good quality paper.
	Preservation temperature is too high.	Please preserve in about 20 degrees temperature.
Power off automatic	Out of power	Please charge.

**Note:**It can make words blurry in short time if use bad quality paper.